

VOORAANZICHT - VUE FRONTALE
VORDERANSICHT - FRONT VIEW

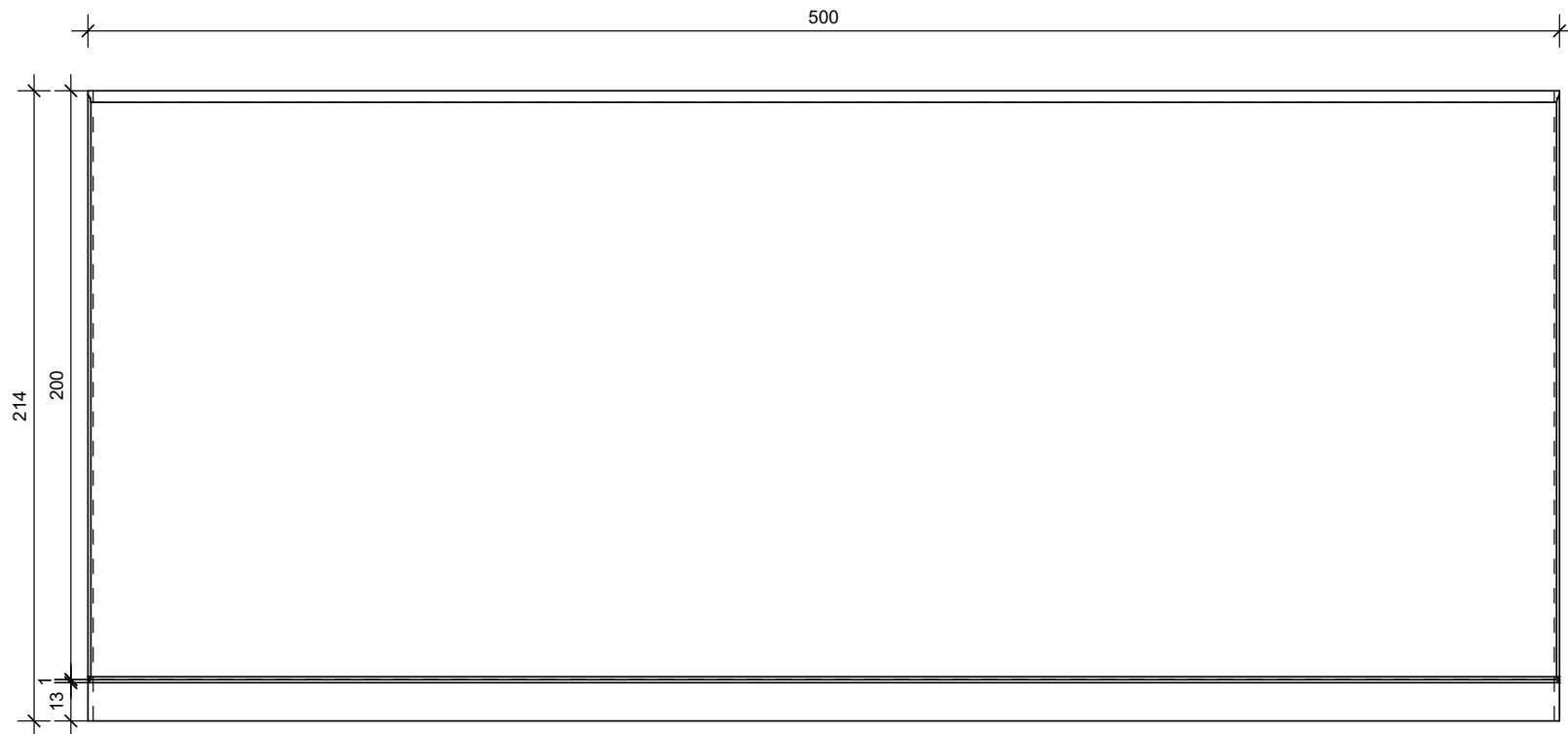

DOORSNEDE - COUPE TRANSVERSALE
QUERSCHNITT - CROSS SECTION

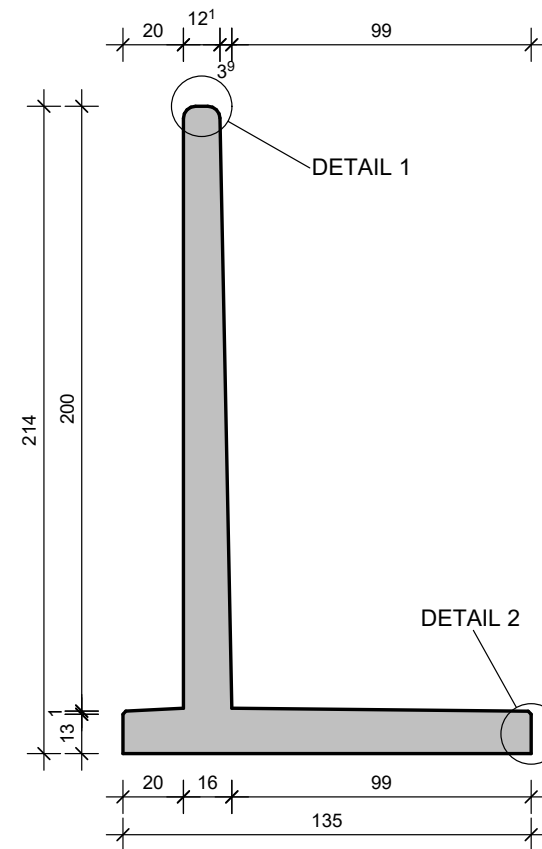

3D

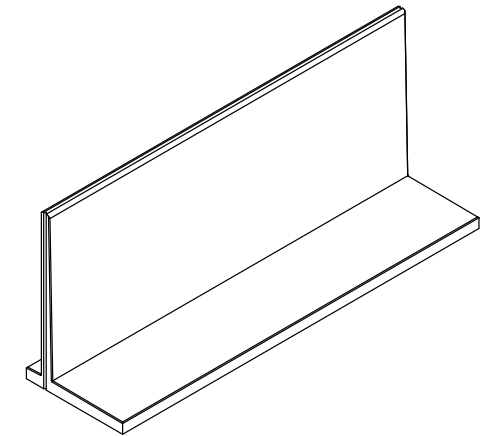

TECHNISCHE FICHE / FICHE TECHNIQUE
TECHNISCHE DATEN / TECHNICAL DATA

element / élément / Element / element

DLAGRI 214x500

sterkteklasse / classe de résistance Festigkeitsklasse / strength class	C60/75
sterkte bij levering / résistance lors de la livraison Festigkeit bei Lieferung / strength at delivery	/
betondekking / enrobage de béton Betondeckung / concrete cover	30mm
milieuklasse / classe d'exposition Expositionklasse / exposure class (EN 206)	XC4, XF1, XA3
constrctieklasse / classe structurale structural class	S1
staalkwaliteit / qualité de l'acier Stahlgüte / steel quality	B500A

artikelnr. / numéro d'article Article / item number	11955
versie / version Version / version	20170619
productie / production Herstellung / production	Emmen / Wielsbeke
volumen / volume Volumen / volume	2.36 m ³
gewicht / poids Gewicht / weight	5805 kg
ankers / ancrés Anker / anchors	RTA: / KKA: /

BOVENAANZICHT - VUE SUPERIEURE
DRAUFSICHT - TOP VIEW

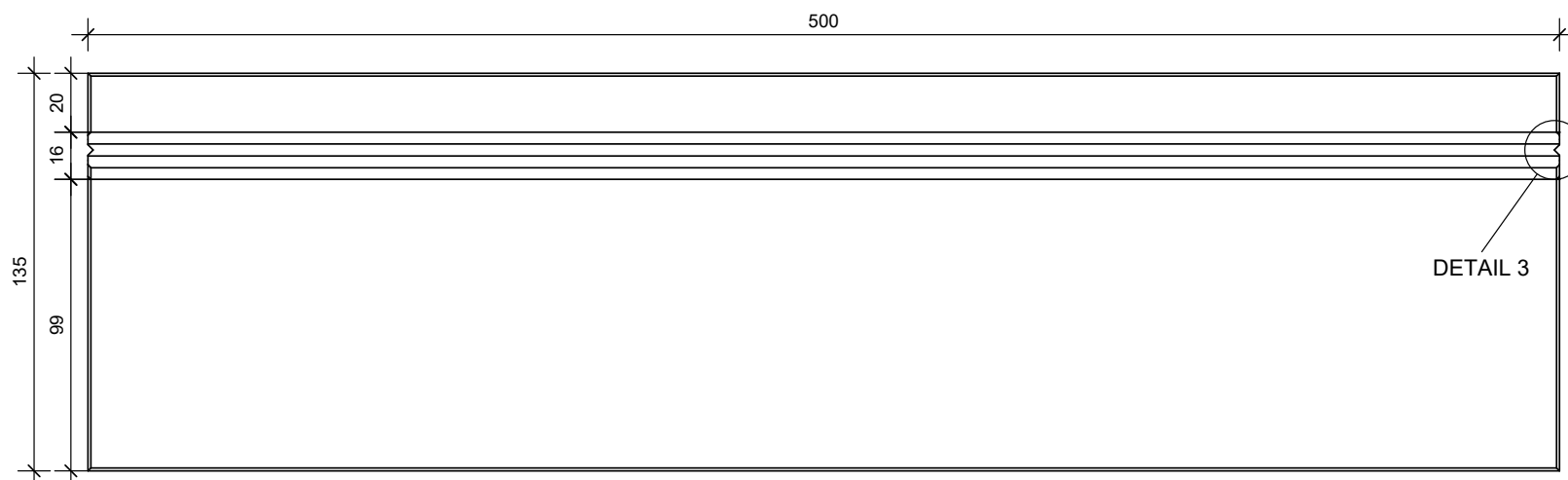

DETAIL 1

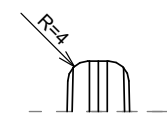

DETAIL 2

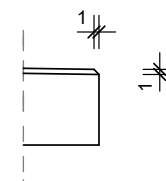

DETAIL 3

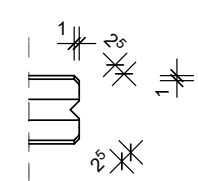

bovenbelasting / surcharge / Auflast / surcharge

15Ton

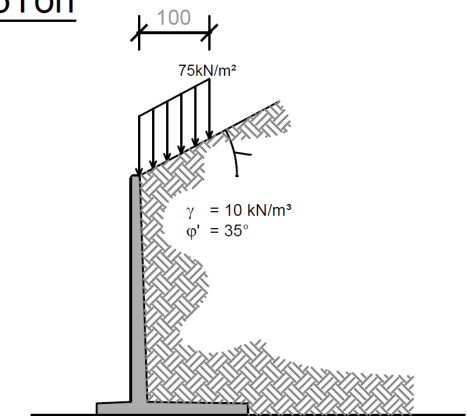

toelaatbare maatafwijking / écart dimensionnel admissible
zulässige Maßabweichung / allowable dimensional deviation

+5mm/-5mm



MBS & CBS Beton BV
Phileas Foggstraat 24D
NL-7825 AK Emmen

Tel. +31 05 91 742 010

info@mbs-csbbeton.nl
www.mbs-csbbeton.nl